

FODM3010 FODM3011 FODM3012 FODM3021 FODM3022 FODM3023

DESCRIPTION

The FODM301X and FODM302X series consists of a GaAs infrared emitting diode driving a silicon bilateral switch housed in a compact 4-pin mini-flat package. The lead pitch is 2.54 mm. They are designed for interfacing between electronic controls and power triacs to control resistive and inductive loads for 115V/240V operations.

FEATURES

- Compact 4-pin surface mount package (2.4 mm maximum standoff height)
- Peak blocking voltage
250V (FODM301X)
400V (FODM302X)
- Available in tape and reel quantities of 500 and 2500.
- Applicable to Infrared Ray reflow (230°C max, 30 seconds.)
- BSI, CSA and VDE certifications pending
- UL (File# E90700) certified

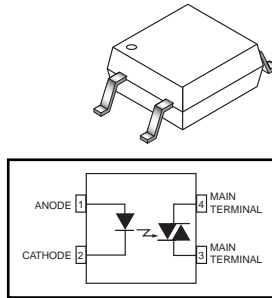

APPLICATIONS

- Industrial controls
- Traffic lights
- Vending machines
- Solid state relay
- Lamp ballasts
- Solenoid/valve controls
- Static AC power switch
- Incandescent lamp dimmers
- Motor control

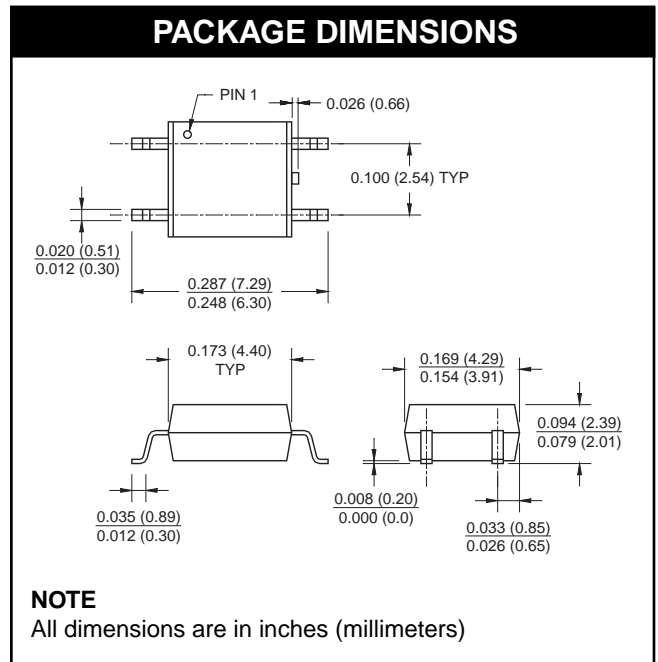

ABSOLUTE MAXIMUM RATINGS ($T_A = 25^\circ\text{C}$ unless otherwise specified)			
Parameter	Symbol	Value	Units
TOTAL PACKAGE			
Storage Temperature	T_{STG}	-40 to +125	$^\circ\text{C}$
Junction Temperature	T_J	125	$^\circ\text{C}$
Operating Temperature	T_{OPR}	-40 to +85	$^\circ\text{C}$
EMITTER			
Continuous Forward Current	I_F (avg)	60	mA
Peak Forward Current (1 μs pulse, 300 pps.)	I_F (pk)	1	A
Reverse Input Voltage	V_R	3	V
Power Dissipation (No derating required over operating temp. range)	P_D	100	mW
DETECTOR			
On-State RMS Current	$I_{T(RMS)}$	70	mA (RMS)
Off-State Output Terminal Voltage	V_{DRM}	FODM3010/1/2	250
		FODM3021/2/3	400
Power Dissipation (No derating required over operating temp. range)	P_D	300	mW

FODM3010 FODM3011 FODM3012 FODM3021 FODM3022 FODM3023

ELECTRICAL CHARACTERISTICS ($T_A = 25^\circ\text{C}$)

INDIVIDUAL COMPONENT CHARACTERISTICS

Parameter	Test Conditions	Symbol	Device	Min	Typ*	Max	Unit
EMITTER							
Input Forward Voltage	$I_F = 10 \text{ mA}$	V_F	All		1.20	1.5	V
Reverse Leakage Current	$V_R = 3 \text{ V}, T_A = 25^\circ\text{C}$	I_R	All		0.01	100	μA
DETECTOR							
Peak Blocking Current Either Direction	Rated $V_{\text{DRM}}, I_F = 0$ (note 1)	I_{DRM}	All		2	100	nA
Peak On-State Voltage Either Direction	$I_{\text{TM}} = 100\text{mA peak}$	V_{TM}	All		1.7	3	V
Critical Rate of Rise of Off-State Voltage	$I_F = 0$ (Figure 8, note 2)	dv/dt	All		10		$\text{V}/\mu\text{s}$

TRANSFER CHARACTERISTICS ($T_A = 25^\circ\text{C}$)

DC Characteristics	Test Conditions	Symbol	Device	Min	Typ*	Max	Unit
LED Trigger Current	Main Terminal Voltage = 3V (note 3)	I_{FT}	FODM3010			15	mA
			FODM3021				
			FODM3011			10	
			FODM3022				
			FODM3012			5	
			FODM3023				
Holding Current, Either Direction		I_H	All		300		μA

ISOLATION CHARACTERISTICS

Characteristic	Test Conditions	Symbol	Device	Min	Typ*	Max	Unit
Steady State Isolation Voltage	(1 Minute)	V_{ISO}	All	3750			VRMS

* All typicals at $T_A = 25^\circ\text{C}$

Note

1. Test voltage must be applied within dv/dt rating.
2. This is static dv/dt . See Figure 1 for test circuit. Commutating dv/dt is function of the load-driving thyristor(s) only.
3. All devices are guaranteed to trigger at an I_F value less than or equal to max I_{FT} . Therefore, recommended operating I_F lies between max I_{FT} (15 mA for FODM3010 and FODM3021, 10 mA for FODM3011 and FODM3022, 5 mA for FODM3012 and FODM3023) and absolute max I_F (60 mA).

TYPICAL PERFORMANCE CURVES

Fig. 1 LED Forward Voltage vs. Forward Current

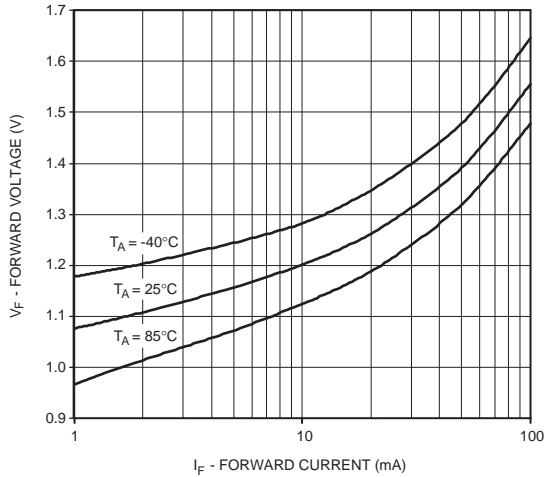

Fig. 2 Leakage Current vs. Ambient Temperature

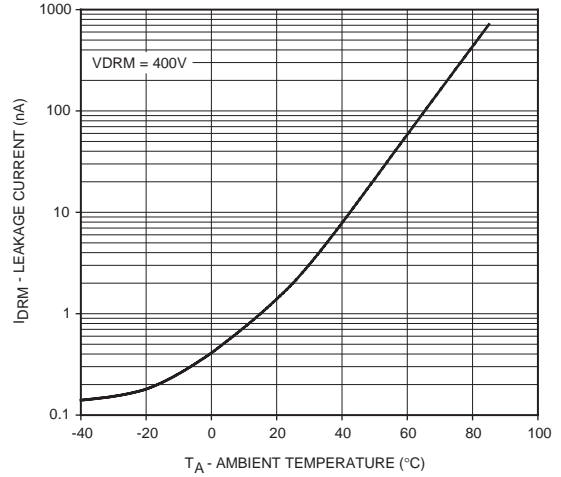

Fig. 3 Holding Current vs. Ambient Temperature

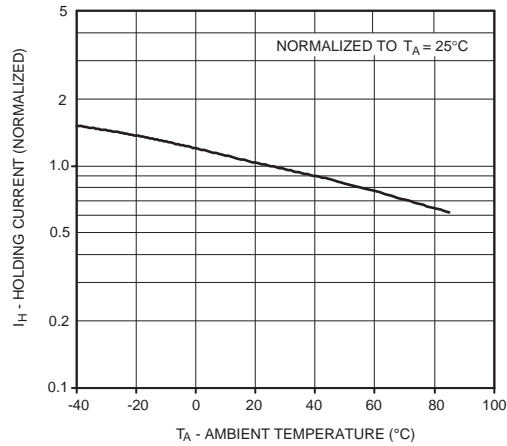
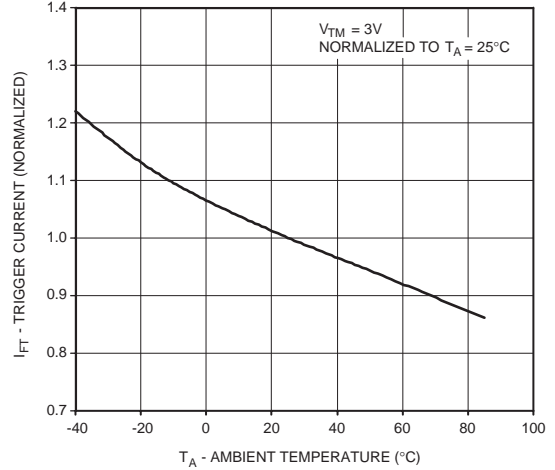

Fig. 4 Trigger Current vs. Ambient Temperature



TYPICAL PERFORMANCE CURVES

Fig. 5 LED Current Required to Trigger vs. LED Pulse Width

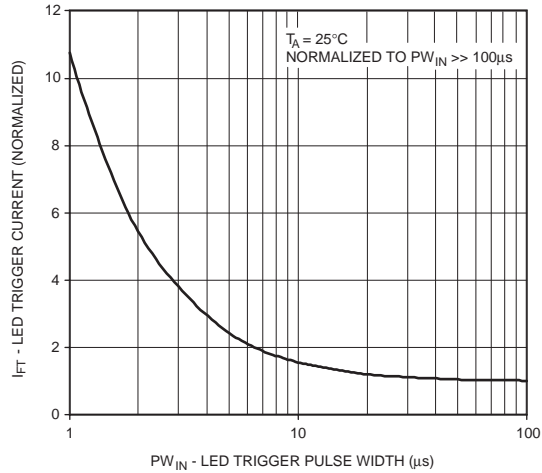

Fig. 6 Off-state Output Terminal Voltage vs. Ambient Temperature

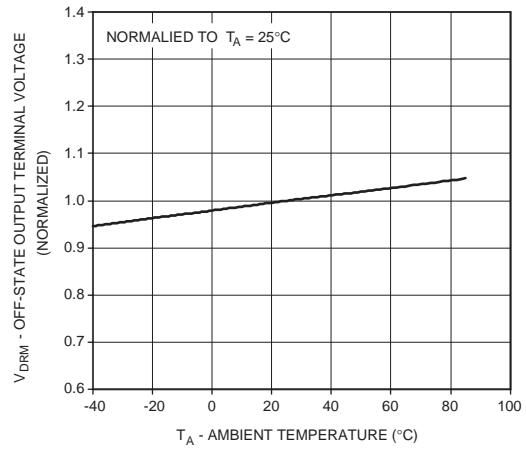
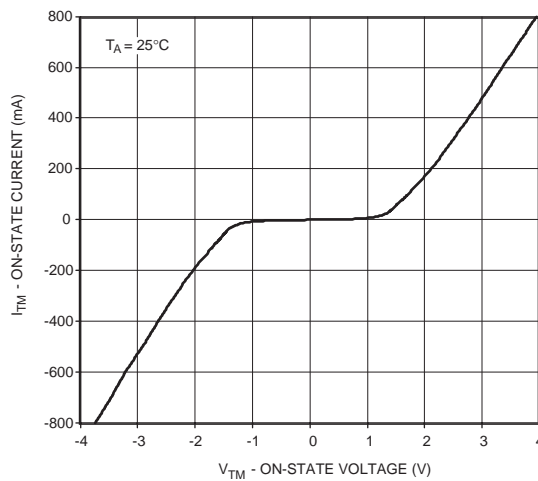
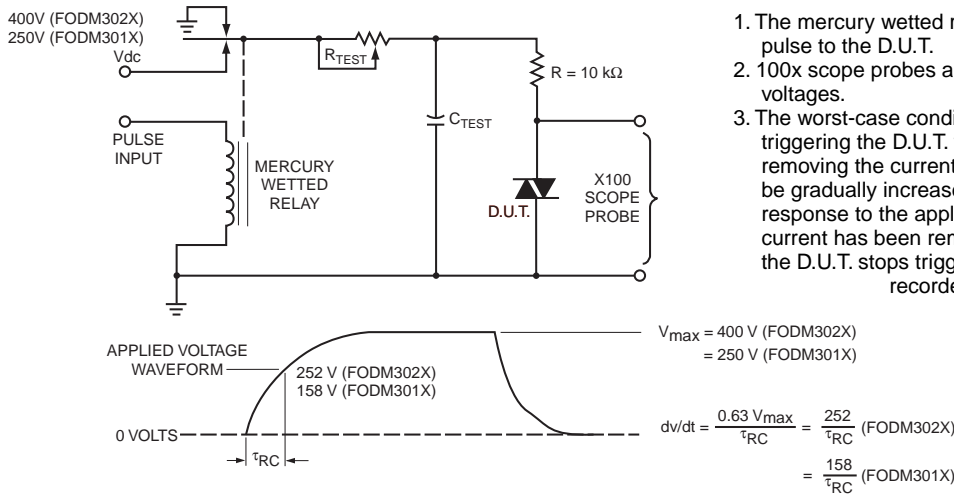

Fig. 7 On-State Characteristics



TYPICAL PERFORMANCE CURVES



1. The mercury wetted relay provides a high speed repeated pulse to the D.U.T.
2. 100x scope probes are used, to allow high speeds and voltages.
3. The worst-case condition for static dv/dt is established by triggering the D.U.T. with a normal LED input current, then removing the current. The variable R_{TEST} allows the dv/dt to be gradually increased until the D.U.T. continues to trigger in response to the applied voltage pulse, even after the LED current has been removed. The dv/dt is then decreased until the D.U.T. stops triggering. τ_{RC} is measured at this point and recorded.

Figure 8. Static dv/dt Test Circuit

NOTE: This optoisolator should not be used to drive a load directly. It is intended to be a trigger device only.

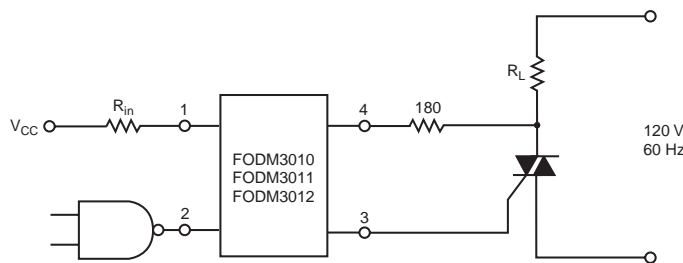

Figure 9. Resistive Load

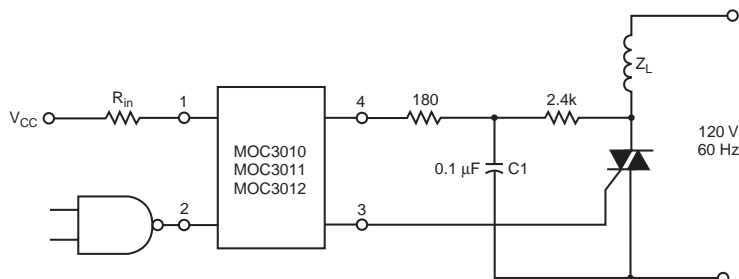

Figure 10. Inductive Load with Sensitive Gate Triac (I_{GT} ≤ 15 mA)

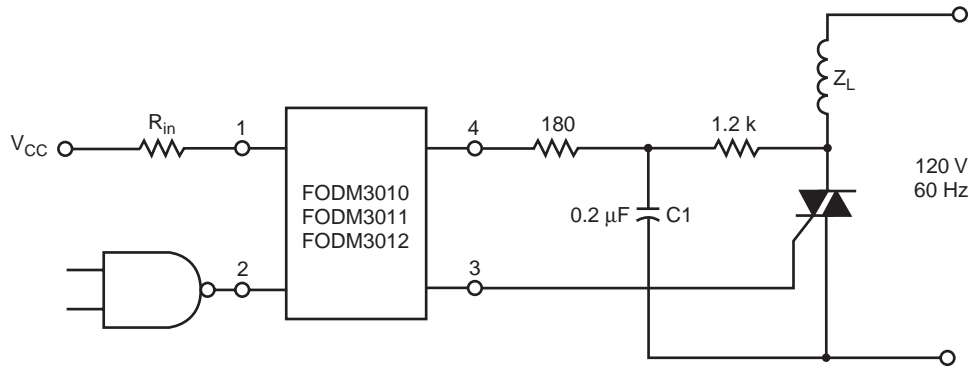
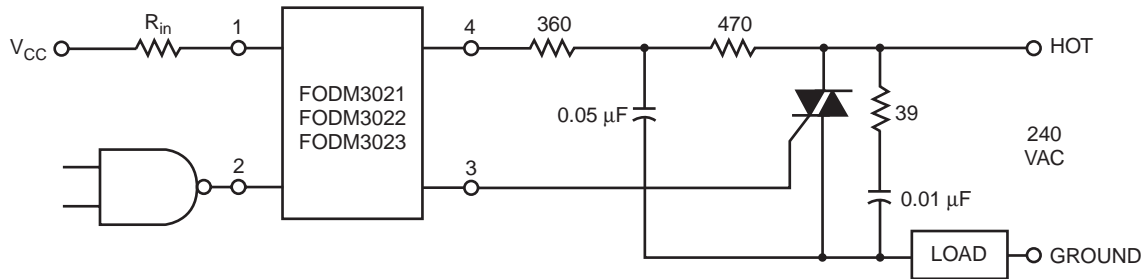

Figure 11. Inductive Load with Sensitive Gate Triac ($I_{GT} \leq 15 \text{ mA}$)



In this circuit the “hot” side of the line is switched and the load connected to the cold or ground side.

The 39 ohm resistor and 0.01 μF capacitor are for snubbing of the triac, and the 470 ohm resistor and 0.05 mF capacitor are for snubbing the coupler. These components may or may not be necessary depending upon the particular and load used.

Figure 12. Typical Application Circuit

FODM3010 FODM3011 FODM3012 FODM3021 FODM3022 FODM3023

ORDERING INFORMATION

Option	Description
V	VDE Approved
R1	Tape and Reel (500 units)
R2	Tape and Reel (2500 units)
R3	Tape and Reel (500 units; unit 180° rotated)
R4	Tape and Reel (2500 units; unit 180° rotated)
R1V	Tape and Reel (500 units) and VDE Approved
R2V	Tape and Reel (2500 units) and VDE Approved
R3V	Tape and Reel (500 units; unit 180° rotated) and VDE Approved
R4V	Tape and Reel (2500 units; unit 180° rotated) and VDE Approved

MARKING INFORMATION

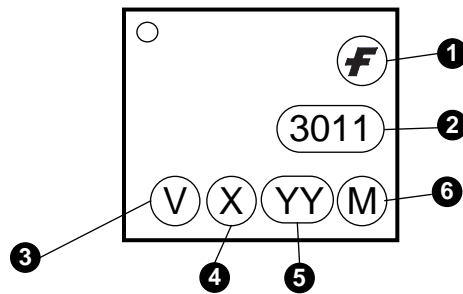

Definitions	
1	Fairchild logo
2	Device number
3	VDE mark (Note: Only appears on parts ordered with VDE option – See order entry table)
4	One digit year code
5	Two digit work week ranging from '01' to '53'
6	Assembly package code

FODM3010 FODM3011 FODM3012 FODM3021 FODM3022 FODM3023

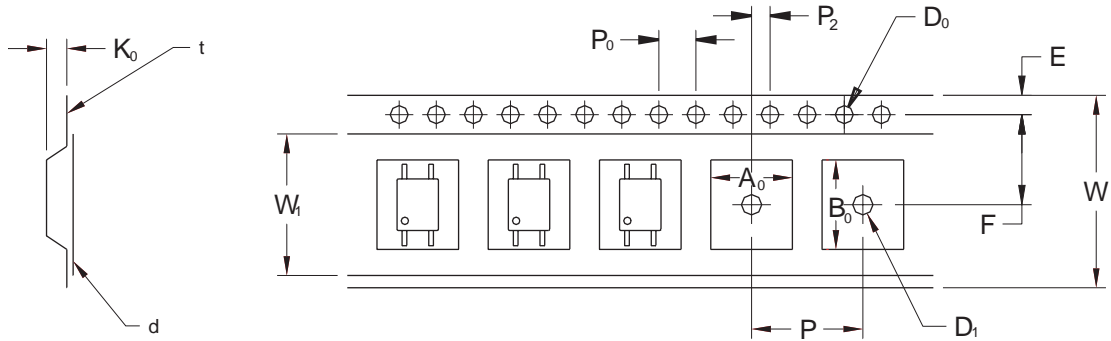

Description		Symbol	2.54 Pitch Dimensions (mm)
Tape Width		W	12.00±0.4
Tape Thickness		t	0.30±0.20
Sprocket Hole Pitch		P ₀	4.00±0.20
Sprocket Hole Dia.		D ₀	1.55±0.20
Sprocket Hole Location		E	1.75±0.20
Pocket Location		F	5.50±0.20
		P ₂	2.00±0.20
Pocket Pitch		P	8.00±0.20
Pocket Dimension		A ₀	4.40±0.20
		B ₀	7.30±0.20
		K ₀	2.30±0.20
Pocket Hole Dia.		D ₁	1.55±0.20
Cover Tape Width		W ₁	9.20
Cover Tape Thickness		d	0.065±0.02
Max. Component Rotation or Tilt			20° max
Devices Per Reel	R1		500
	R2		2500
Reel Diameter	R1		178 mm (7")
	R2		330 mm (13")

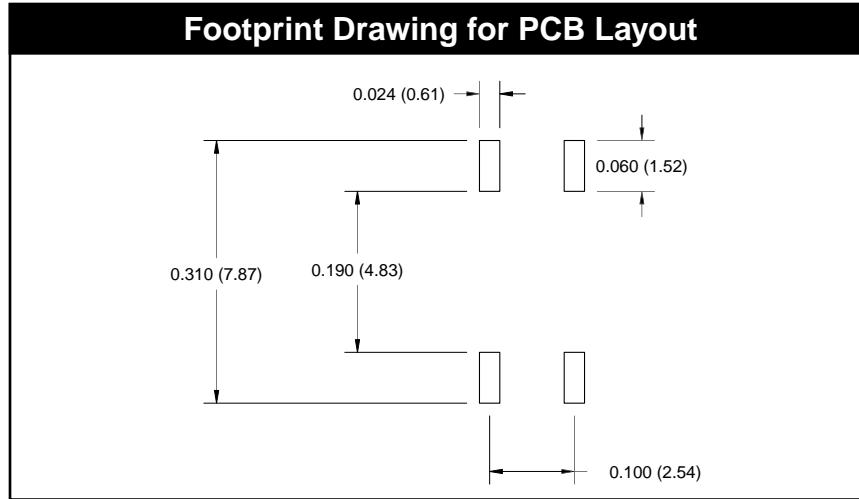

Recommended Infrared Reflow Soldering Profile

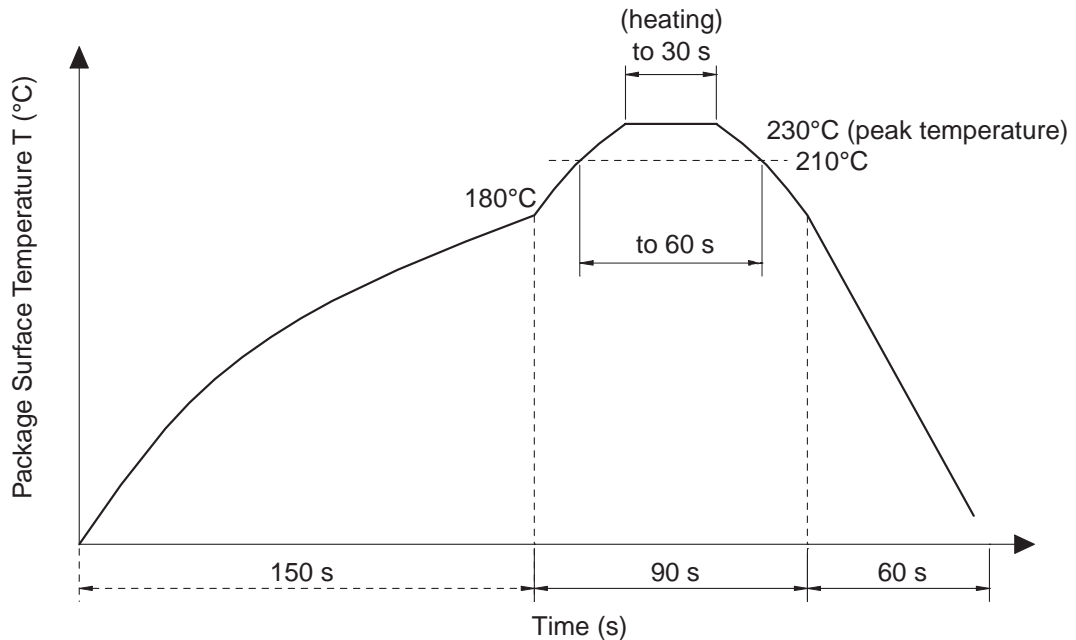

- Peak reflow temperature: 230°C (package surface temperature) for 30 seconds
- Time of temperature higher than 210°C: 60 seconds or less
- One time soldering reflow is recommended

FODM3010 FODM3011 FODM3012 FODM3021 FODM3022 FODM3023

DISCLAIMER

FAIRCHILD SEMICONDUCTOR RESERVES THE RIGHT TO MAKE CHANGES WITHOUT FURTHER NOTICE TO ANY PRODUCTS HEREIN TO IMPROVE RELIABILITY, FUNCTION OR DESIGN. FAIRCHILD DOES NOT ASSUME ANY LIABILITY ARISING OUT OF THE APPLICATION OR USE OF ANY PRODUCT OR CIRCUIT DESCRIBED HEREIN; NEITHER DOES IT CONVEY ANY LICENSE UNDER ITS PATENT RIGHTS, NOR THE RIGHTS OF OTHERS.

LIFE SUPPORT POLICY

FAIRCHILD'S PRODUCTS ARE NOT AUTHORIZED FOR USE AS CRITICAL COMPONENTS IN LIFE SUPPORT DEVICES OR SYSTEMS WITHOUT THE EXPRESS WRITTEN APPROVAL OF THE PRESIDENT OF FAIRCHILD SEMICONDUCTOR CORPORATION. As used herein:

1. Life support devices or systems are devices or systems which, (a) are intended for surgical implant into the body, or (b) support or sustain life, and (c) whose failure to perform when properly used in accordance with instructions for use provided in the labeling, can be reasonably expected to result in a significant injury of the user.
2. A critical component in any component of a life support device or system whose failure to perform can be reasonably expected to cause the failure of the life support device or system, or to affect its safety or effectiveness.